

Rodeca U-Panels

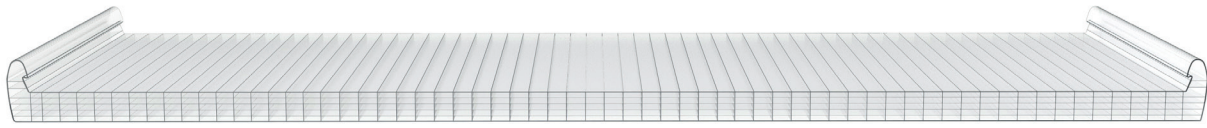

Characteristics

width:	630 mm
thickness:	16 mm
Up-value:	approx. 1,9 W/m ² K
weight:	approx. 3,2 kg/m ²
layer/chambers:	6 layer / 5 chambers
fire classification:	B-s1,d0 acc. EN 13501
tolerances:	EN 16153
bending radius:	min. 3,50m
light transmission:	crystal approx. 61% opal approx. 33%
colours:	crystal, opal color & DuoColor on request

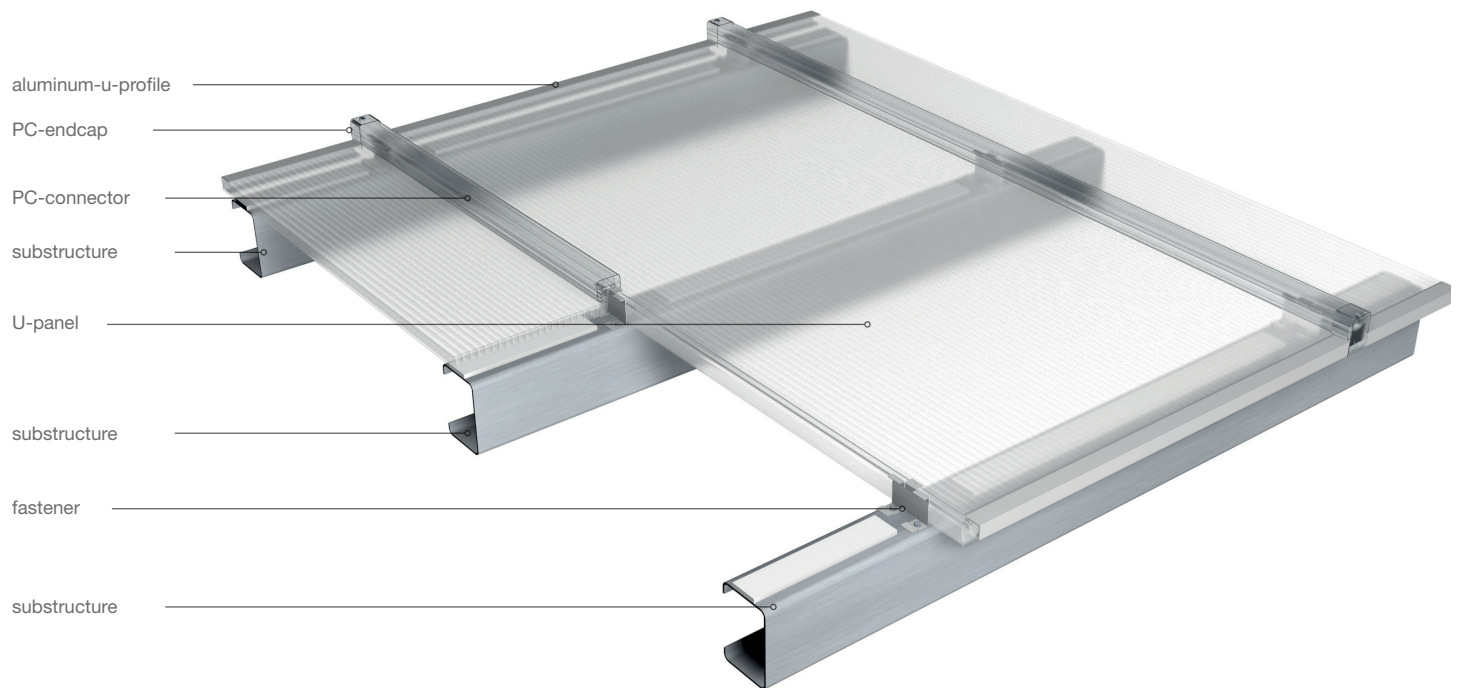
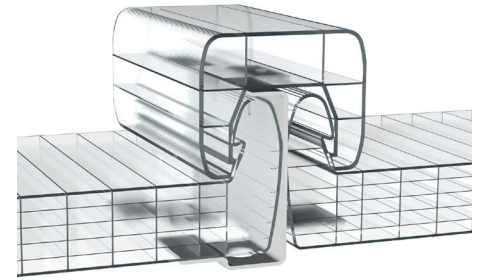

Load resistance

The information on load resistance relates to the failure of the panels or accessories.
The values do not contain any safety factors and do not replace any country-specific and building law certificates.

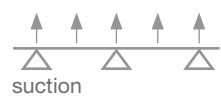

span	load
1,0 m	1,7 kN/m ²
1,5 m	1,4 kN/m ²

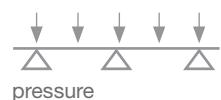

1,0 m	2,4 kN/m ²
1,5 m	1,6 kN/m ²

Accessories

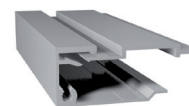

side profile
aluminium-u-profile
461640 + 492001

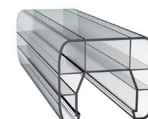

Polycarbonat
connector
380062

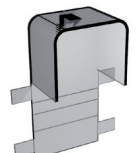

Polycarbonat
endcap
395008



front end
aluminium-u-profile
461611

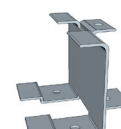

fastener
494016N

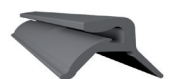

gasket for side profile
902901

Overview U-Panels

Rodeca U-Panels

PC 2600-10-4-U



width: 600 mm
thickness: 10 mm
Up-value: approx. 2,6 W/m²K

colours:
crystal / opal /
color

PC 2630-16-6-U / PC 2630-16-6-U HD



width: 630 mm
thickness: 16 mm
Up-value: approx. 1,9 W/m²K

colours:
crystal / opal /
color / Duocolor

PC 2630-20-6-U

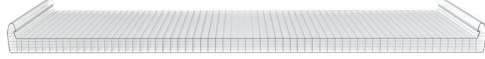

width: 630 mm
thickness: 20 mm
Up-value: approx. 1,7 W/m²K

colours:
crystal / opal /
color

PC 2630-25-6-U / PC 2630-25-6-U HD



width: 630 mm
thickness: 25 mm
Up-value: approx. 1,6 W/m²K

colours:
crystal / opal /
color / Duocolor

