

Installation manual

PC 2250-C

Scope of delivery

PC Panel PC 2250-C

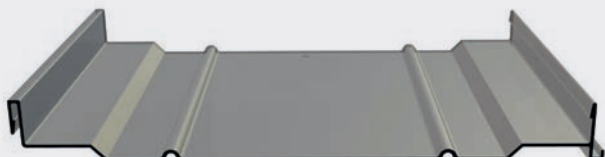

Art.No.: PC 2250-C

Fastener stainless steel



Art.No.: 494007

Before installation

Please check the delivery for completeness and note our general information on storage and our assembly instructions! The scope of delivery of the Rodeca system includes the polycarbonate panels "PC 2250-C" and stainless steel fasteners "Art. No.: 494007", which are to be attached to an on site substructure.

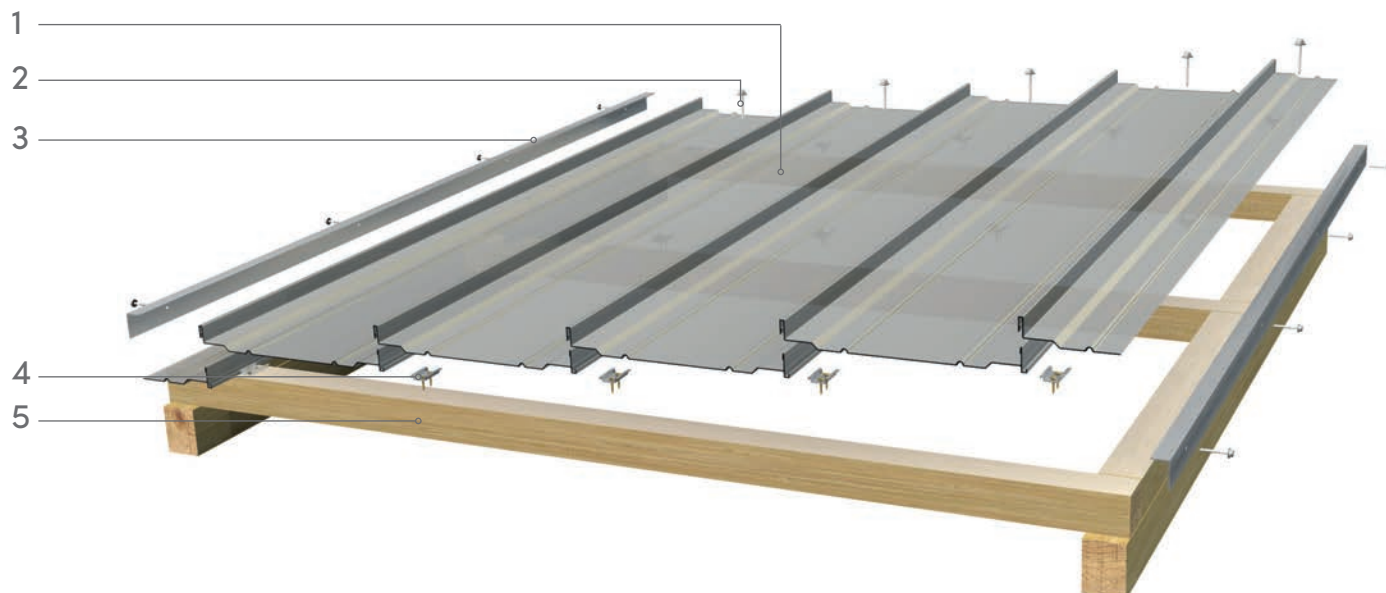

1. Polycarbonate Panel PC 2250-C
2. Screw with washer to fix the panels
3. Angle for laterally attaching the cut panels
4. Fastener Art.No.: 494007
5. Substructure

Installation manual

PC 2250-C



Substructure

The substructure should be chosen as light as possible or painted light. A purlin distance of max. 50cm should not be exceeded.



Centering out the PC panels

The total area must be averaged out before installation begins so that panels of approximately the same width can be installed at the edges.

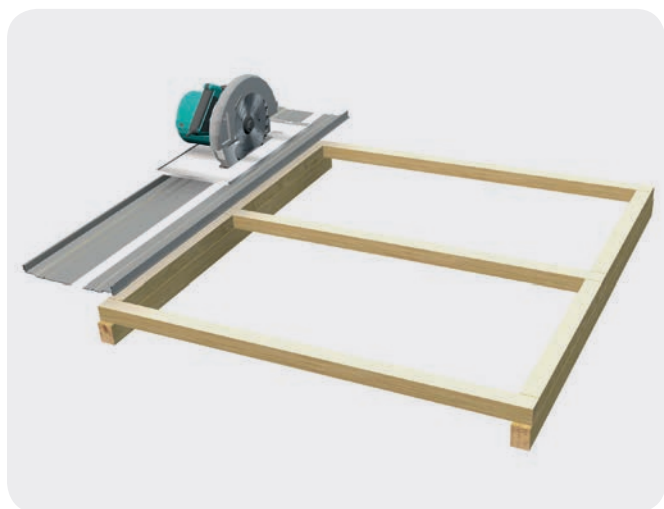

Cut first panel

The first panel needs to be cut lengthwise. For this purpose, commercially available tools such as jigsaws or circular saws with fine-toothed saw blades or angle grinders with appropriate cutting discs can be used.

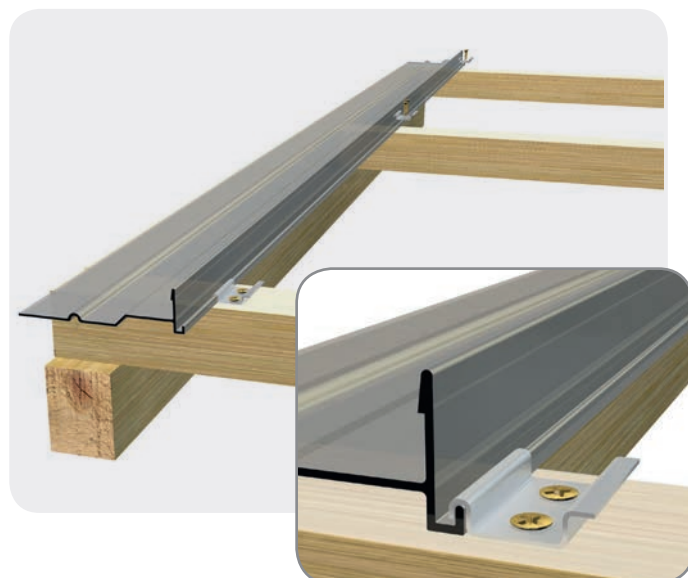

Fasten the PC panels

The stainless steel fasteners must be placed in the appropriate places on the panels and screwed to the substructure. It is important to ensure that the panel can expand unhindered.

Installation manual

PC 2250-C

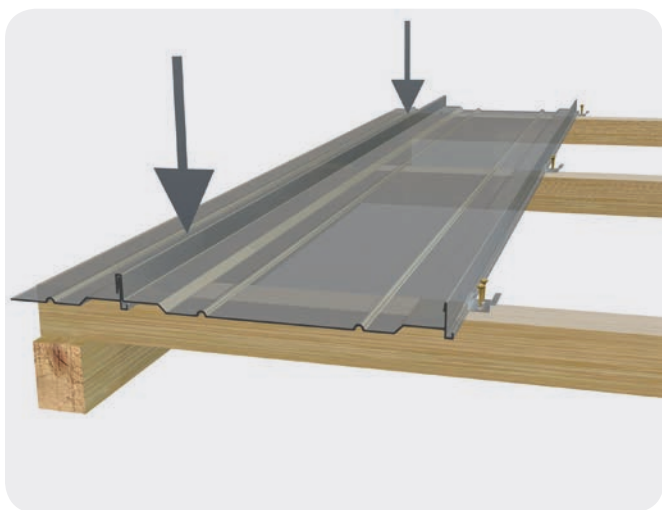

Assembling further panels

The following panels must be pressed on one after the other from above until the connection between the panels clicks into place completely and over the entire length. Each panel must be attached to the substructure with fasteners as described above.

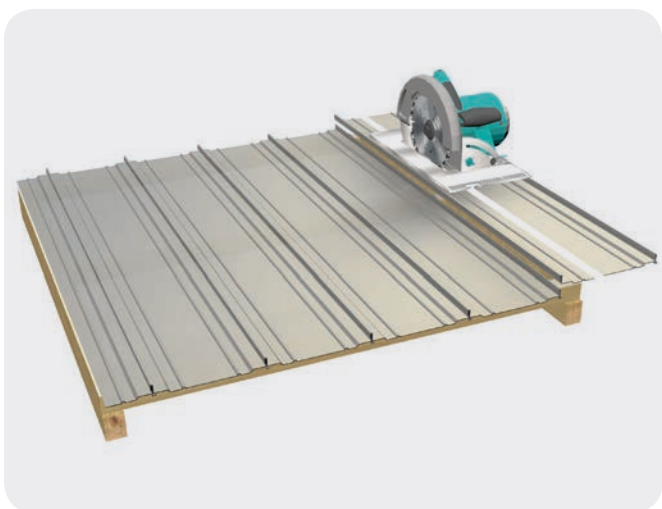

Cut the last panel

The last panel needs to be cut lengthwise. For this purpose, commercially available tools such as jigsaws or circular saws with fine-toothed saw blades or angle grinders with appropriate cutting discs can be used.

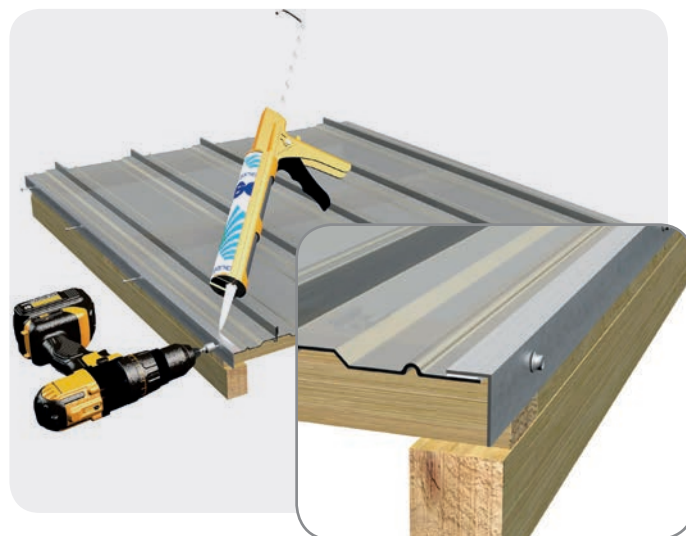

Fastening the side panels

The side panels must be attached with an angle profile. Polycarbonate-compatible silicone or sealing tape must be used to seal between panel and angle.

Installation manual

PC 2250-C

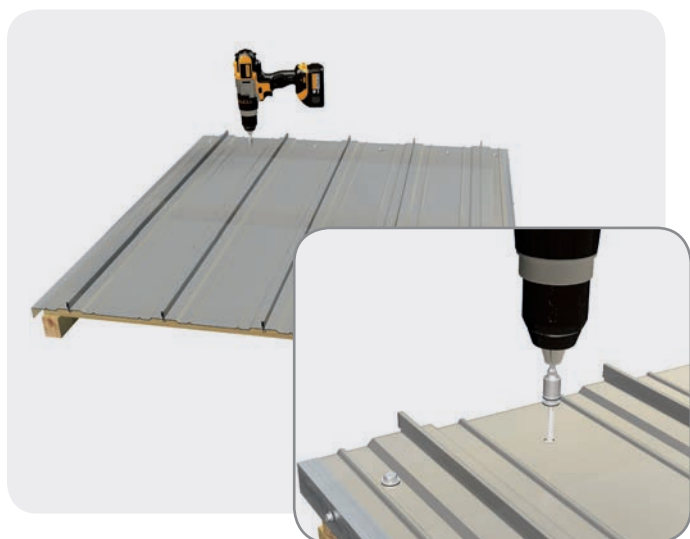

Safety screws

Each panel must be fixed to the upper support using a screw with a sealing washer. All drill holes must be pre-drilled for this purpose.

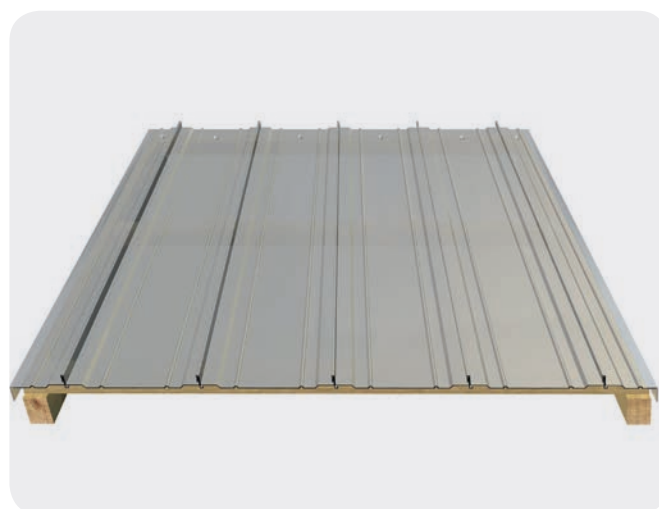

Cleaning and care

Regular cleaning of the polycarbonate panels is essential. To do this, use a soft brush or a soft cloth with water and a small amount of neutral cleaner. No glass cleaners, abrasive agents, alkaline cleaners, surfactant-containing cleaners or sharp-edged objects may be used.