

Translucent Building System

rodeca[®]
Translucent Building Elements

Your specialist for translucent building elements



Translucent building elements 60 mm

**Translucent building elements
made of polycarbonate for seamless glazings**

System PC 2560-12



Index of contents

Index of contents	page 2
General information	page 3-7
Overview translucent building system	page 8
Colours and effects	page 9
Technical information translucent building elements	
• PC 2560-12	page 10
Product range aluminium frame profiles	page 11-13
Product range aluminium special profiles	page 14-15
Product range aluminium fastener	page 16
Calculation of the panels' lengths	page 17-19
Product range window sills, accessories and adapter profiles	page 20-22

General Information

The raw material

Polycarbonate (PC) is a crystal clear, high impact thermoplastic.

Advantages

- Temperature resistance between -40 to +115°C, temporarily up to +130 °C
- High impact resistance nearly unchanging within these temperatures
- Good long term performance through UV protection

UV co-extrusion

With this technique a high concentrated UV protection film is homogeneously melted onto the basis material while production process.

This offers the following advantages:

- No adhesion problems of UV protection film
- Same temperature behaviour of base and UV material
- No impairment of high impact (like e.g. with coated or painted surfaces)
- Makes small cold bending radiuses possible.
- Better resistance against environmental influences and ageing.
- The thickness of the Coextrusion layer may influence the colouring.

Outside Performance

Through the coextruded UV-protection film – which is always applied on the outer wall and if desired (surcharge) for some of the products is also available both-sided – our products offer best weather resistance and very good long term performance.

Warranty

Rodeca offers 10 years warranty (according to written warranty) to its uv-coextruded products regarding to **yellowing index – ageing – hail**

Light transmission

Customized on project demand Rodeca can produce products with light transmission from almost 0% up to 80% light transmission (depending on material thickness and number of layers). Due to in-house compounding and raw material refineration special requests and colours can be realized. Please inquire project demands which vary from our standards.

G-Value (Solar gain value, overall energy transmittance)

The overall energy transmittance indicates how much of external solar energy reaches the interior of the room. For optimum passive use of solar energy, the g-value should be as high as possible and as deep as possible for optimum sun protection.

Up-values and Uf-values (heat transmission coefficient - Up=U-value panel; Uf =U-value frame)

Throughout the multi-walled design of our translucent building elements translucent facades with thermally broken aluminium profiles can be designed very energy efficient.

UV transmission

UV-radiation is stopped almost to 100% up to 380 Nm because of high UV-stabilization with coextruded UV-protection. The remaining transmission in the area of UV radiation is less than 1%. This property can be very important for UV sensitive goods.

IR-radiation transmission

Our panels with HEATBLOC-surface let through day light and reflect and stop at the same time selectively the heating radiation. The effect is cooler rooms through lower solar gain values.

Reflection of radar radiation

In the near of radar-units (e.g. at airports) it is important to have none or minimized influence through building elements. Rodeca products do not have influence on reflection and do not affect radar-units.

Service temperature

Service temperature is between minus 40 °C up to plus 115 °C (temporarily up to 130 °C). Please take into consideration service temperature especially with rain screen claddings respectively the use of dark foils for deposition of translucent building elements. Adequate distances and sufficient ventilation need to be considered in planning. That way danger of heat accumulation and associated deformations can be avoided.

Thermal properties

The high deformation resistance from shortly up to 130 °C is one of the advantages which Rodeca products with coextruded surface offer. Rodeca products can be used in spaces where other thermoplastics cannot be used anymore. Interesting to know is that white surfaces on roof applications already can heat up to +100°C. (It is essential to respect thermal expansion/shrinking of polycarbonate and to avoid heat accumulation.)

Colouring

The usual colours are:

- CLEAR with structure for panels for higher light transmission, light refraction. Additionally the surface is less sensitive to scratches.
- OPAL for optimized diffused light.
- COLOR Series - transparent or semitransparent COLOURS, similar to RAL from approx. 300 m2 on request
- BICOLOR Series - two coloured inish, inner wall coloured, similar to RAL from approx. 150 m2 on request
- DUOCOLOR - two coloured inish of translucent building elements custom made in transparent or semitransparent COLOURS similar to RAL from approx. 300 m2 on request
- DECOCOLOR - two coloured inish, outer wall coloured, similar to RAL from approx. 150 m2 on request

Qualities

Depending on application area and demand Rodeca produces different qualities.

- LONGLIFE quality for one sided UV protection. The terms can be extracted from our 10 years warranty declaration for LBE, MFP and U-Panels "longlife"
- LONGLIFE PLUS quality for one sided UV protection quality for special requirements. The terms can be extracted from our 10 years warranty declaration for LBE, MFP and U-Panels "longlife plus".

Impact resistance/fracture behaviour

Rodeca products made of PC are due to the raw material practically indestructible through beat, impact, stone throwing etc. Polycarbonate is 200 times more impact resistant than glass. Polycarbonate building elements do not splinter and comply with German regulations on workplaces (Arbeitsstättenverordnung).

Hail resistance

Currently doesn't exist a DIN standard, so our Rodeca elements were tested at EMPA (Swiss testing laboratory) with a simulated hail test with a shot radius of 20 mm and no holes occurred. According to the current testing results we achieve the highest class (class 5) of the Swiss hail test with factory-new goods.

Ball rebound safety

Ball rebound safety was tested and passed according to DIN 18032 part 3. Please inquire the test report if required.

Fire resistance

Polycarbonate has a very high ignition temperature of approx. 450 °C and in case of fire the smoke development is very little. Rodeca products are classified according to the European standard DIN EN 13501 and are classified as hardly inflammable. Additionally the fire resistance of our products is classified according to various national standards. Please inquire the test certificates when needed.

Meltable area

In many fire protection concepts Rodeca panels are considered as melt-surface according to DIN 18230-1 because the softening point of PC is below 300°C.

Sound insulation

Polycarbonate panels have a sound insulation value up to 22 dB according to DIN EN ISO 10140-2. With a double wall construction a considerably higher value can be achieved. The value refers to the panel only and may differ due to structural conditions.

Chemical resistance

PC elements possess a very high resistance to chemicals but can be affected through some chemical bounds. Chemical resistance of polycarbonate against other used chemicals has to be checked by customer on site. This is especially important for cooling substances, lubricants, surfactants, sealants, ammonia, etc. A policy on the compatibility of polycarbonate with chemicals can be found i.a. at: <http://www.buerkle.de/en/knowhow/information/chemical-resistance.html>

Painting

In case that the polycarbonate panels for advertising reasons or similar will be painted or screen printed the compatibility of the painting system needs necessarily be tested from customer before use. The aluminium frame profiles can be powder coated according to the project needs. Additionally Rodeca offers the possibility to deliver TPE seals in custom made colours.

Vinyl wrap

For advertising purposes large scale letters can be glued onto the panels' surface. It is important that the foil and the glue doesn't contain substances which harm and affect polycarbonate. Please clarify before usage with the vinyl wrap supplier or the advertising company if the ingredients/glues of the foil intended to use are compatible with Polycarbonate.

Cleaning/Maintenance

For durable maintenance of technical and visual properties a regular care, maintenance and cleaning of the translucent building elements is mandatory. The cycles of care, maintenance and cleaning depends on the particular building site and the usage conditions.

Cleaning of translucent building elements: Pure water cleaning systems (osmosis process) have proven themselves. In addition to surface cleaning with soft brushes, if dirt is present in the area of the coupling, the deposited dirt can be cleaned using a high-pressure cleaner in conjunction with the pure water method.

Alternatively, water with a small percentage of neutral cleaning agents. No use of glass cleaner, rubbing agents or sharp edged subjects. No alkaline or tensile agents to be used.

Storage/Transport

Rodeca panels made of polycarbonate have to be protected before sun and wet conditions before installation and must be stored on a plain and even underground. In case of non-observance stock damages may occur. The stacking height of translucent building elements shouldn't exceed 200 cm.

Safety

The regional building regulations as well as the general safety regulations for non supporting wall and roof coverings are effective. For a perpetration (according to workplace ordinance (German „Arbeitsstättenrichtlinie“) it is mandatory to use a board of 50 cm width.

Packaging

The translucent building elements are delivered – depending on the finish – with one-sided or both-sided protective foil. The delivery is carried out – depending on length – from one to four pieces for hand unloading in a recyclable plastic wrapping or on pallet (for forklift unloading). Please unpack briefly before installation to avoid contamination in the hollow chambers. The protective film may only be removed during treatment and processing. It must be removed at the latest after completion of the assembly! The protective film does not replace any building protection film. Long-term exposure and a larger supply of heat mean that the film can no longer be removed! Heat accumulation and heat with the protective film still in place must be avoided.

Processing

The Polycarbonate Elements can be smoothly cut with common tools, e.g. pad saw (saw blade with fine indentation) Incidental shavings are to be removed with oil free and water free compressed air.

Sealing

Sealings and sealing tapes need to be polycarbonate compatible and approved for usage from respective producer otherwise damages on the panels are possible.

Silicone: Must be absolutely neutral and solvent free, e. g. Rodeca PC-Silicone 2001. The aluminium profiles need to be protected (according to state of the art technique) against galvanic corrosion and an adequate sealing of building has to be done.

Expansion/Shrinking

The expansion coefficient of polycarbonate is 0,065 mm per °C and per m and hence three times as high as the expansion coefficient of aluminium. Due to the expansion of the panels, construction-related noises (cracking) can occur.

Rule of thumb: 3mm per m for 50 °C difference in temperature. Due to temperature differences the length and width of the panel change. The changes in length of the panel need to be considered constructional. Rodeca has considered the length expansion in its system accessories. Thermally caused corrugations can not be excluded completely.

Condensation

Polycarbonate is a material that is permeable for vapour diffusion so that condensation may occur. This is not a quality defect. Depending from weather/climate this appearance is of temporary nature which is directly linked to temperature and humidity. Condensation doesn't effect the quality of the panels.

Formation of algae

Algae can just occur in connection of dirt and humidity. Taping of the polycarbonate panels prevents appearance of dirt while stocking and transport.

Aluminium frame profiles

Aluminum frame profiles shall be treated in accordance with the unloading and storage regulations. Mill finish aluminium with oxidative staining is not accepted as reclamation reason. Due to production reasons, the end faces of thermally separated frame profiles are to be trimmed by the customer. Coated or anodised frame profiles can have bores or discolourations of the clamping points of the anodizing process at the lateral ends and are to be shortened if necessary on site. This is not accepted as reclamation reason. Coated profiles can have color deviations to other components in the same color. The chemical resistance of aluminum must be observed. Care and maintenance of aluminum profiles can preserve the optical properties and texture. **Safety**

The regional building regulations as well as the general safety regulations for non supporting wall and roof coverings are effective. For a perpetration (according to workplace ordinance (German „Arbeitsstättenrichtlinie“) it is mandatory to use a board of 50 cm width.

Tolerances according to EN 16153

Panels

Length + 12 mm (up to 3 m) / +0.40 % of panel length (above panel length of 3 m)

Thickness ± 0.5 mm

Width -2 mm / +6 mm

Weight - 5 %

Concavity length ± 5 mm per linear meter of panel length

Concavity width ± 5 mm per linear meter of panel width

Rectangularity < 5 mm per linear meter of panel length

All tolerances are based on room temperature of approx. 20 °C.

Variations in colour saturation and shade between several production batches cannot be precluded (production-related). Variations are always possible and will not be accepted as reason for complaint.

Disposal of waste/Environmental protection

Rodeca takes leftovers from off-cuts etc. back. Packaging is fully recyclable.

Sealing of panel ends

The ends of the panels must be closed before installation - directly after unpacking - with suitable sealing to avoid dust and dirt in the chambers.

With a sealing that is permeable for vapour diffusion (or permeable to water) you run risk that dust, diesel exhaust particulates, gases or other fine particles can diffuse into the panel chambers. For projects with increased particulate matter emission respectively environmental pollution are additionally precautions to be taken. With a joint sealing and additional sealing methods the optical properties of the translucent building materials can be maintained. Every element needs to be sealed singularly. A general recommendation for sealing of panel ends can't be given due to the different installation situations. The complete lack of panel ends sealing cannot be recommended from our experience.

Joint permeability

Rodeca panels were tested on joint in terms of wind and driving rain. For complete constructions project specific blower door tests have been passed.

System accessories

For almost all installation situations Rodeca supplies appropriate and well engineered accessories as well as ventilation flaps and windows in many different versions.

ETA (European Technical Assessment)

Rodeca panel (LBE) systems are CE marked as specified by the European directive No. 305/2011 and according to ETA 19/0452. The European Technical Assessment - ETA for short - is a European product certification. It is requested in particular for construction products for which there is no harmonized standard. At the same time, ETA authorizes a CE marking. It is mandatory that usability of single certificates is checked in advance from planner /client.

Environmental Product Declaration (EPD)

To enable qualified building certification, we provide an EPD for our light building elements. The Type III declaration according to ISO 14025 and EN 15804 provides reliable data on the environmental characteristics of the products and thus facilitates the sustainability assessment of buildings. Among other things, it contains important information on the life cycle of the products. This includes, in particular, the environmental key figures required for a certification scheme of buildings. These were calculated for all tongue and groove panels and shown from the cradle to the grave.

Miscellaneous

Data subject to technical change.

The aforesaid information and our application technological advice in words, written and through tries, are carried out to best of one's knowledge. This information is non-binding advice even in regards to property rights of third parties. Our advice does not release you from your responsibility to proof self dependently our current advices - especially our safety data sheets and technical information - and to test if our products in regards to applicability for the intended system and use. Application, use and handling of our products – produced from you based on our application technological advice - take place out of our control and therefore you are solely responsible. The sale of our products is carried out according to our current general terms and conditions. Please check before handling if our products are applicable for the intended purpose.

Overview translucent building system 60 mm

PC 2560-12

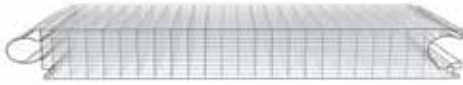

Width	500 mm	Colours
Thickness	60 mm	crystal / opal / Color / DuoColor
U _p -value*	0.75 W/m ² K	

*U_p-Value vertical application

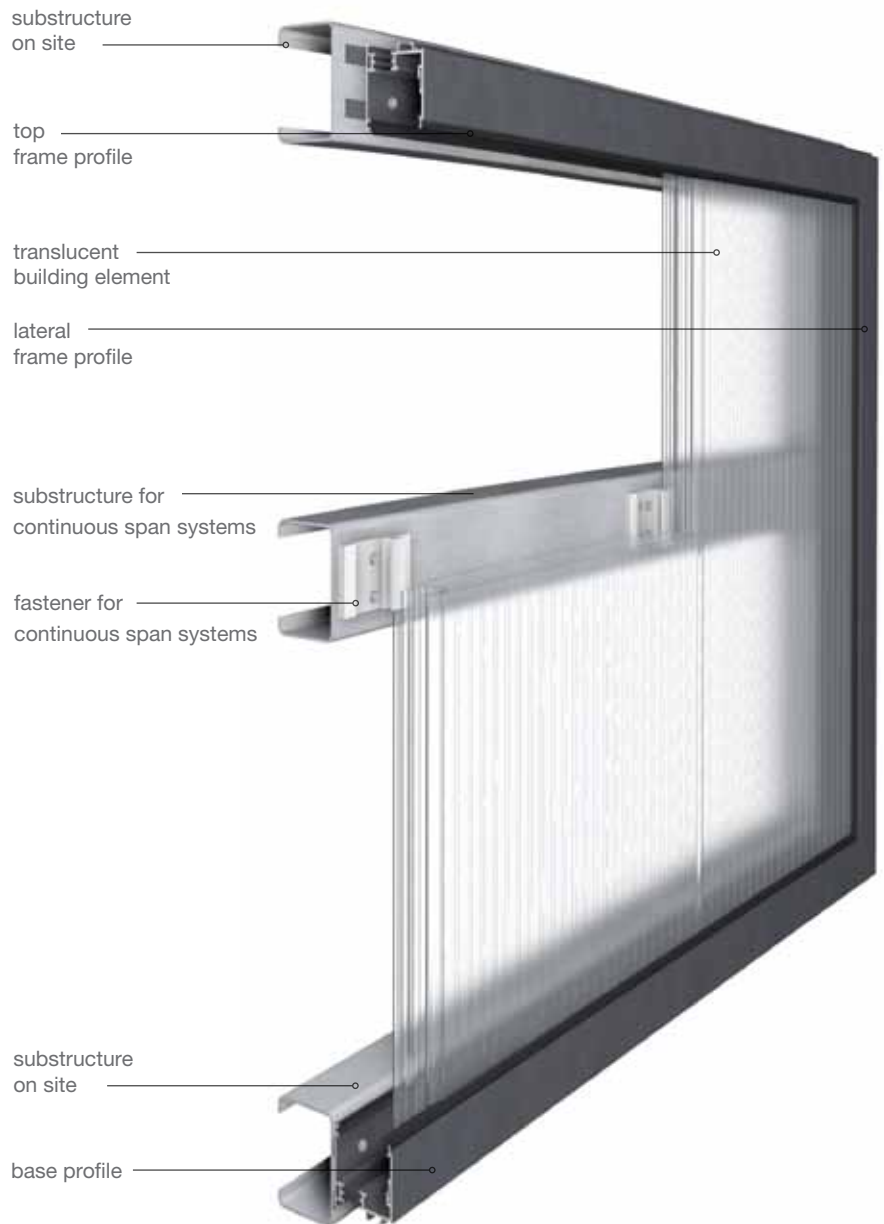

Colours and design options

Crystal and opal



All Rodeca panels are available in clear and opal versions in our standard delivery program.

Color

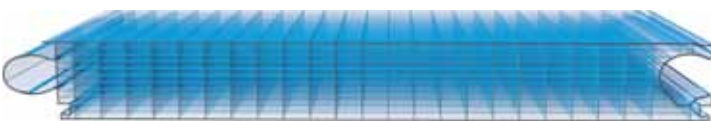

All panels are also available in the Color version. The entire panel is coloured in one colour.

DuoColor

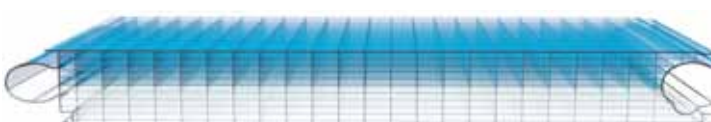

The panel can be coloured in two different colours using our Duo-Color technology. Of course, a combination of crystal and opal is also possible.

Colours

The colour examples shown here are based on defined raw material mixtures.

For sampling the colors we can provide our color sample boxes. In addition, Rodeca offers the unique opportunity to carry out colour developments according to customer requirements. Your desired color can be produced as approx. 4 cm wide solid polycarbonate strips, or directly as a coloured panel, with a contribution to the costs. Please note that the colours and transparency shown in the pictures may differ from the real products.

Colours

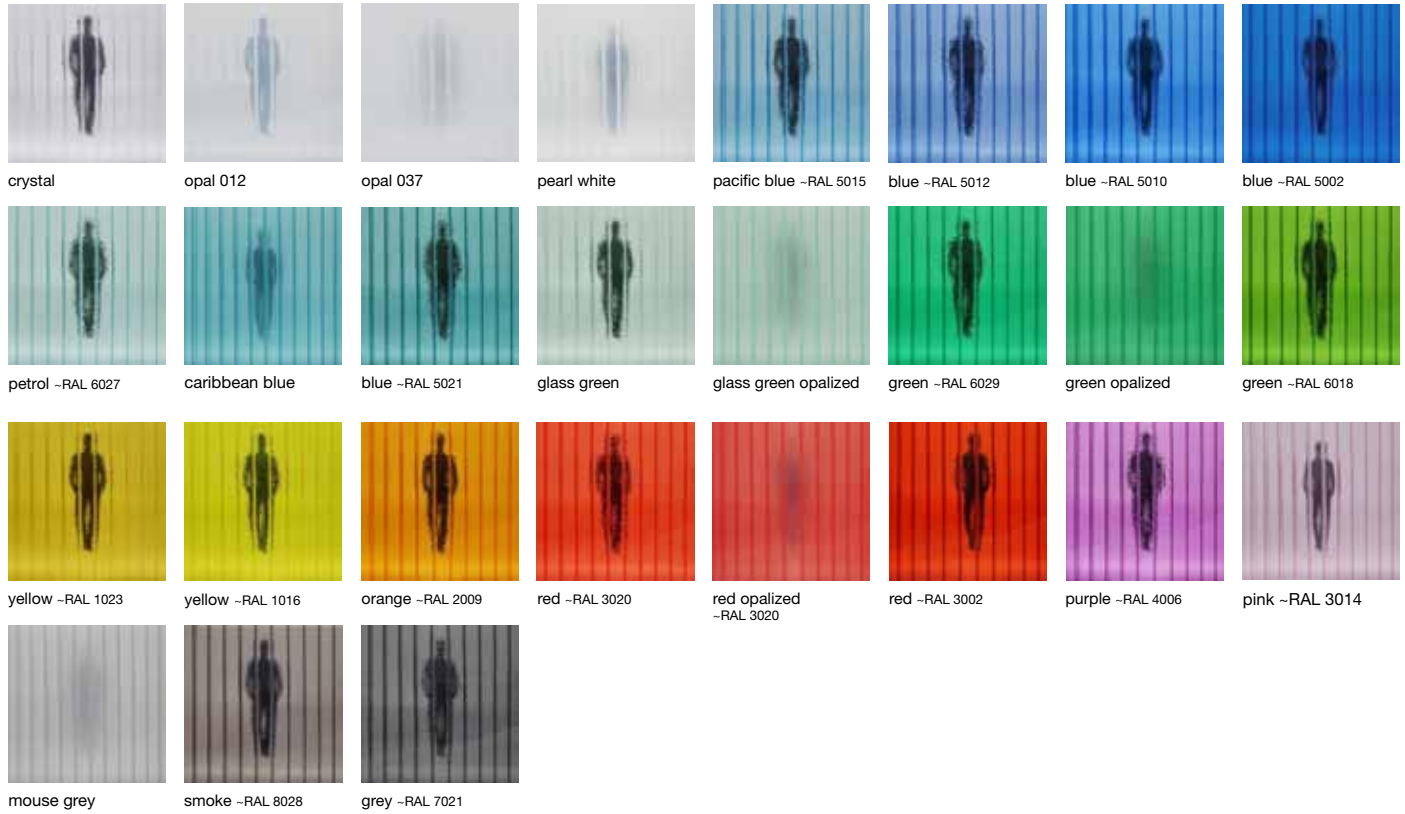

Colours pastel

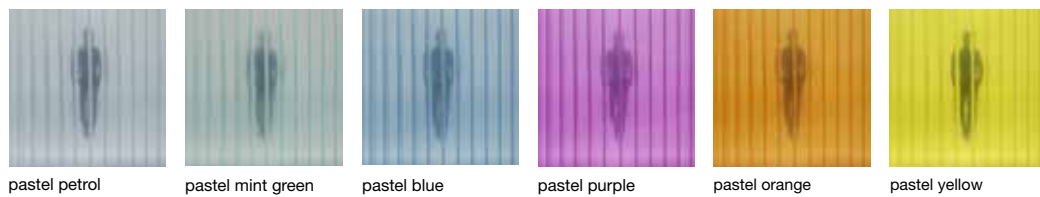

Colours frosted

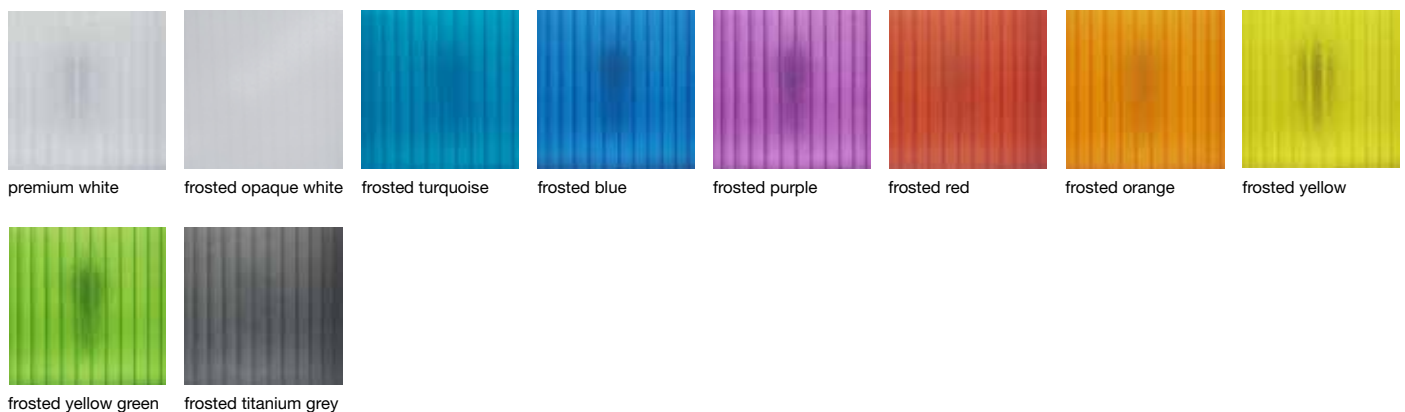

PC 2560-12



Product properties

Building width	500 mm	
Thickness	60 mm	
Weight	approx. 5.8 kg/m ²	
Structure	12 layers / 11 chambers	
U _p -value	0.75 W/m ² K vertical application 0.77 W/m ² K horizontal application	
Sound insulation value	R _w = 22 dB	
Flammability classification	B-s1, d0	
Light transmission values	crystal	approx. 42%
	opal	approx. 18%
DuoColor	crystal - opal	approx. 27%
Solar gain values g	crystal	approx. 45%
	opal	approx. 34%
DuoColor	crystal - opal	approx. 38%
UV admission	< 1 %, wavelengths until 380 nm stopped almost a 100 %	
Coefficient of linear expansion	0.065 mm/m/°C	
ETA	19/0452	
aBG	Z-10.19-835	
Production tolerances s. general information		



Fastener

Fastener AF60 (Article no.: 49406060)	60 mm height	
Fastener AF120 (Article no.: 494060120)	120 mm height	

Span charts

The diagrams below show recommended span widths depending on the type of installation. The values are only valid in connection with original Rodeca system accessories and may not be used as a substitute for project-related static calculations.

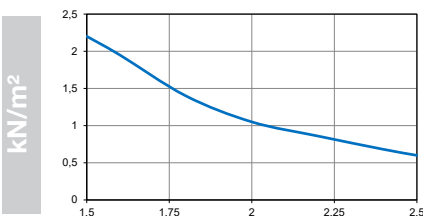
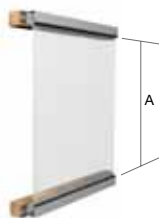

distance A in m

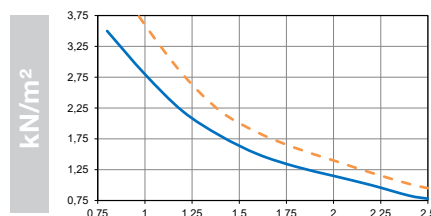
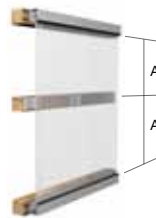

distance A in m

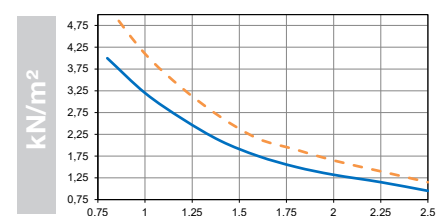
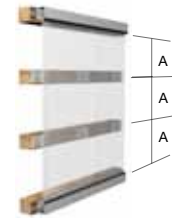

distance A in m

Product range aluminium frame profiles

Types of installation

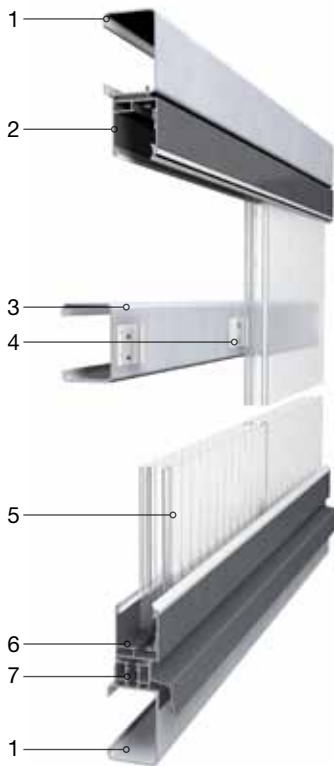

installation in reveal

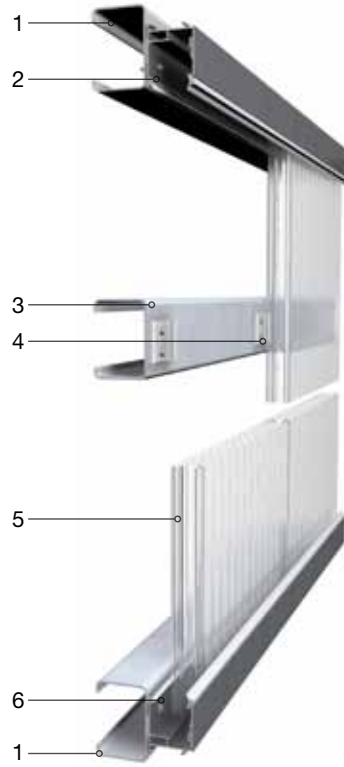

rainscreen installation

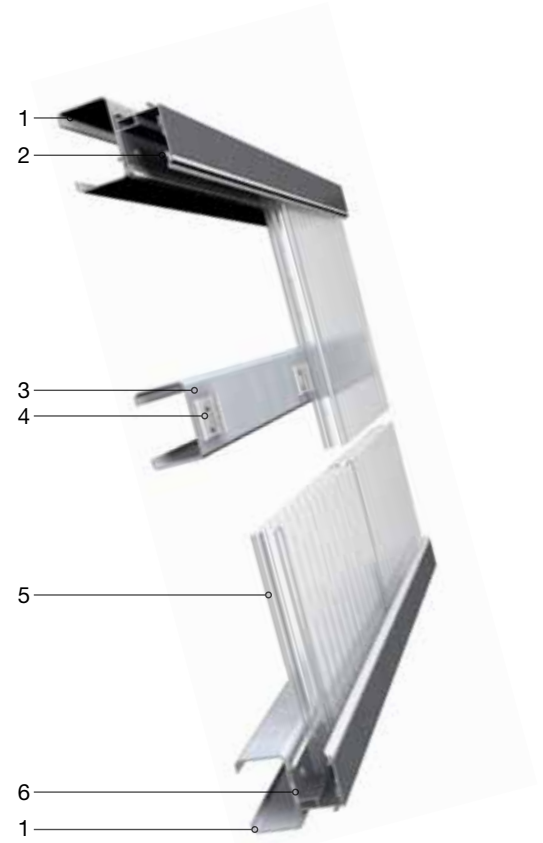

pitched rainscreen installation

- | | |
|---|--|
| 1 | substructure on site |
| 2 | top and lateral frame profile |
| 3 | substructure for continuous span systems |
| 4 | fastener for continuous span systems |
| 5 | translucent building element |
| 6 | base profile |
| 7 | adapter profile (optionally) |

General

The examples shown above illustrate the use of Rodeca frame profiles for mounting in reveal, as rainscreen or as a pitched rainscreen construction. In all cases the sealing between frame sections, frame profile and substructure should be adapted to local conditions. The proof of aluminium profiles, their fixings and the fixing of Rodeca fasteners must be kept in an individual case. The aluminium profiles have to be fixed with **stainless steel screws**, the base profiles have to be fixed with **stainless steel screws** with neoprene seals. Dimensions and size according to substructure and extract values of fixing materials. Rodeca assembly instructions must be observed.

Rodeca frame systems are made of extruded Aluminium profiles consisting of Aluminium EN AW-6060, status T 66 according to DIN EN 755-2. The ribs are made of fiber glass reinforced polyamide PA 66 with fiber glass part of 25%. The seals are made of TPE.

Please note:

The coefficient of linear expansion for Aluminium profiles = 0.023 mm/m°C. Polycarbonate panels = 0.065 mm/m°C.

Installation manuals are available at www.rodeca.de. Please contact us in case of any further questions about the professional implementation of your building project with Rodeca products.

Product range aluminium frame profiles Series 41 non-thermally broken system

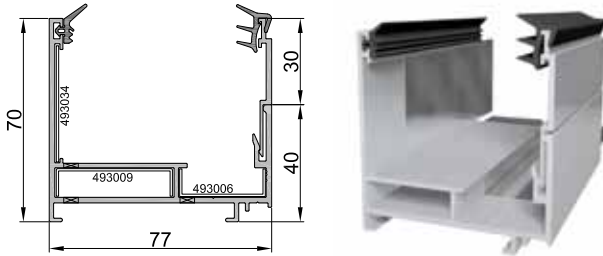

416011	base profile
416012	top and lateral frame profile
416051	base profile for pitched installations
492042/43	front plate

Series 41 - non-thermally broken frame profiles

Finishes mill finish / anodized E6/C0 / powder coated according to RAL	delivery lengths	profile connector (packing unit 4 pcs.)
416011, base profile	6.0 m	493006, 493009, 493034
416012, top and lateral frame profile	6.0 m	493006, 493009, 493034
416051, base profile for pitched installations	6.0 m	493006, 493009, 493034
492042/43, front plate	2.0 and 3.0 m	
902902N, inner seal, TPE grey	50.0 m roll	
902912N, inner seal, TPE black	50.0 m roll	
902801, outer seal, TPE grey	50.0 m roll	
902811, outer seal, TPE black	50.0 m roll	

**Product range aluminium frame profiles
Series 44 / 45 thermally broken system**

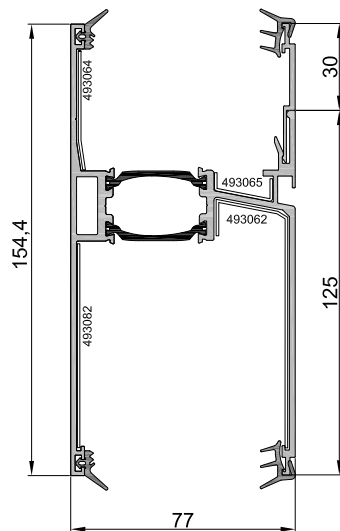
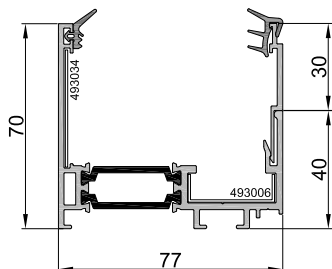

456011	base profile
456012	top and lateral frame profile
492042/43	front plate

446062	traverse profile
492042/43	front plate

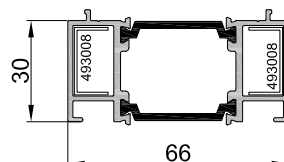
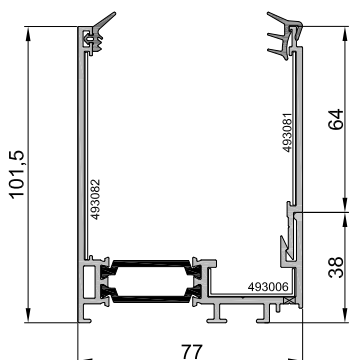

456001	base profile
456002	top and lateral frame profile
492093	front plate

499060	adapter profile for window sills
--------	----------------------------------

Series 44/45 - thermally broken frame profiles

Finishes mill finish / anodized E6/C0 / powder coated according to RAL	delivery length	profile connector (packing unit 4 pcs.)
456011, base profile	6.0 m	493006, 493034
456012, top and lateral frame profile	6.0 m	493006, 493034
456001, base profile	6.0 m	493006, 493082
456002, top and lateral frame profile	6.0 m	493006, 493082
446062, traverse profile	6.0 m	493062, 493064, 493065, 493082
499060, adapter profile for window sills	6.0 m	2x 493008
492042 / 43, front plate	2.0 and 3.0 m	
492093, front plate	3.0 m	493081
902902N, inner seal, TPE grey	50.0 m roll	
902912N, inner seal, TPE black	50.0 m roll	
902801, outer seal, TPE grey	50.0 m roll	
902811, outer seal, TPE black	50.0 m roll	

Product range aluminium frame profiles Special profiles

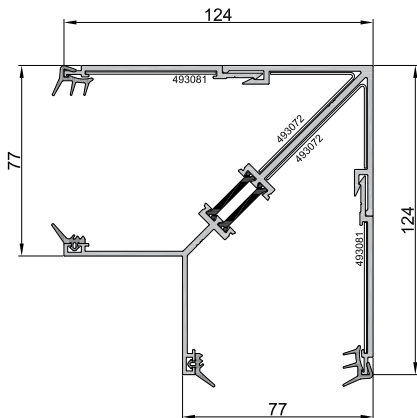

Thermally broken corner profile for 90° building corners

Finishes	delivery lengths	profile connector (packing unit 4 pcs.)
mill finish / anodized E6/C0 / powder coated according to RAL		
456072, aluminium corner profile	6.0 m	2x 493072
492093, front plate	3.0 m	493081

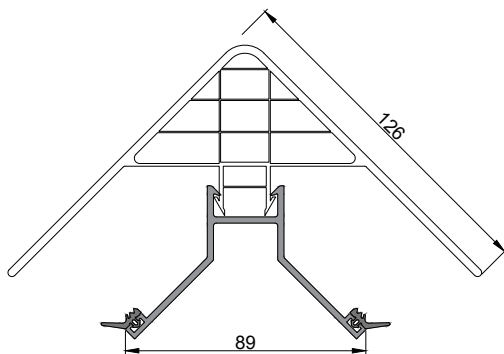

Two-part transparent PC-corner for 90° building corners

Finishes	delivery lengths	profile connector (packing unit 4 pcs.)
mill finish / anodized E6/C0 / powder coated according to RAL		
416072, aluminium profile	6.0 m	
Finishes Polycarbonate crystal		
380072, Polycarbonate profile	pre-cut part up to 13.5 m	

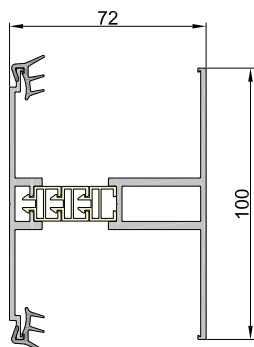

410062.60.5
horizontal bar

Horizontal aluminium bar

Finishes	delivery lengths	profile connector (packing unit 4 pcs.)
mill finish / anodized E6/C0 / powder coated according to RAL		
410062.60.5 horizontal bar	6.0 m	

Product range aluminium frame profiles Special profiles

Corner connections

90° corner connections of profile series 41 and 45 can be offered pre-assembled ex works. The corner connections consist of 550 mm long frame profiles, including front plates, which are connected to one another by pressing. The connection joints are sealed with profile connectors and sealants, thus saving assembly time and effort. When used as a base profile, drip holes must be drilled on site.



inner corner

Pre-fabricated 90° aluminium corners

Finshes	profile combination	profile connector	delivery unit
mill finish / anodized E6/C0 / powder coated according to RAL			
416015, non thermally broken pre-fabricated 90° aluminium corner, incl. front plates 492042/43	416011 / 416012 416051 / 416012	bracket 893009 + 893005, 493036	pcs. (550 x 550 mm)*
456015, thermally broken pre-fabricated 90° aluminium corner, incl. front plates 492042/43	456011 / 456012 416051 / 456012	bracket 893005, 493036	pcs. (550 x 550 mm)*
456005, thermally broken pre-fabricated 90° aluminium corner, incl. front plates 492093	456001 / 456002	bracket 893005, 493003	pcs. (550 x 550 mm)*

*other lengths up to 1,500 mm upon request

Customized profile connections

Horizontal corner connections of the profile series 41 and 45 can also be offered pre-assembled. Optionally with or without connection of the vertical corner profile 456072. On request, we can also produce complete frames or other components for your project. Please contact us!



Product range aluminium profiles Fastener

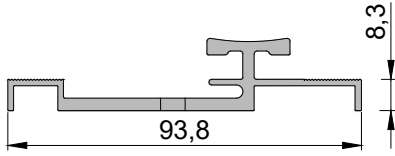

fastener 49406060 / 494060120

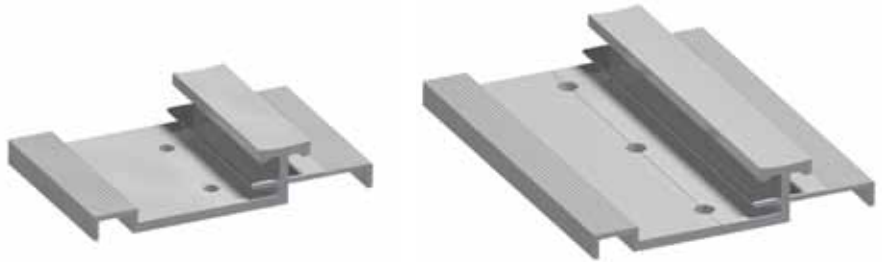

Fastener

Finishes	delivery lengths	translucent building system
mill finish / anodized E6/C0 / powder coated according to RAL		
49406060	60 mm	2560-12 AF60
494060120	120 mm	2560-12 AF120

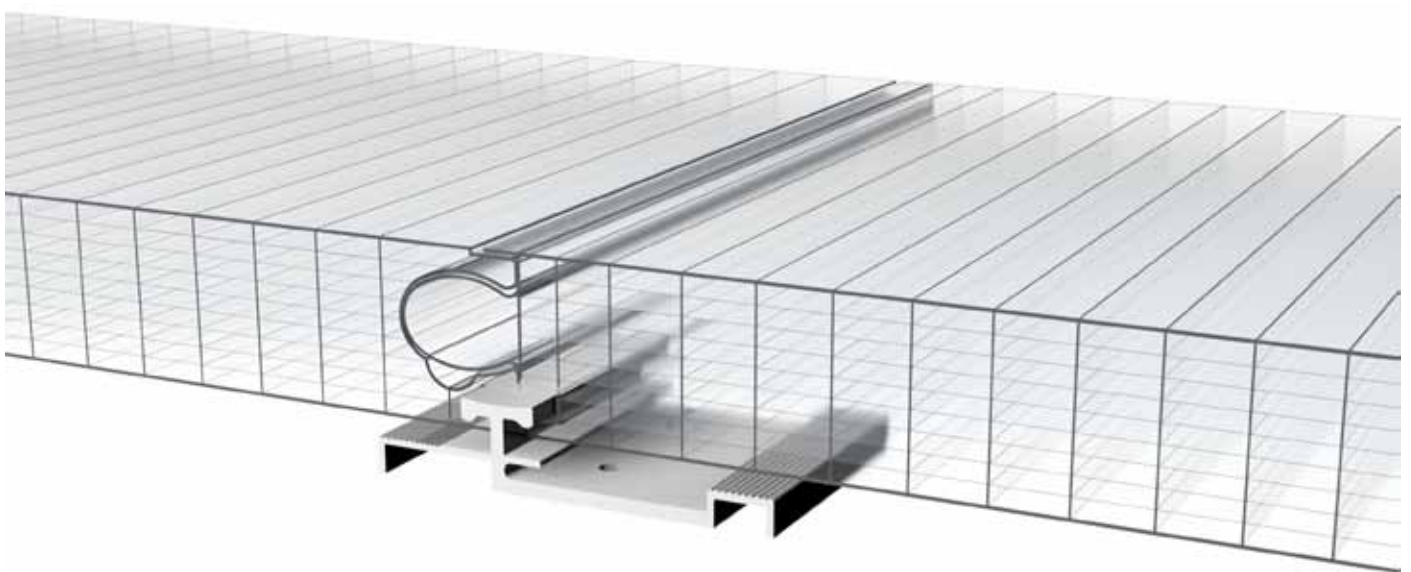

Calculation of the panel length Thermally broken frame system

Façade 90° up to 4.5 m panel length*

* at Central European temperature conditions

top profile 456012
base profile 456011

Calculation of the panel length:

L in mm = height H in mm - 70 mm, at H ≤ 1,500 mm

L in mm = height H in mm - 65 mm, at H > 1,500 mm

Finishes	profile connector (PU 4 pcs.)
mill finish / anodized E6/C0 / powder coated according to RAL	
456012, top and lateral frame profile	493006, 493034
456011, base profile	493006, 493034
492042 / 43, front plate	
902902N, inner seal, TPE grey	
902912N, inner seal, TPE black	
902801, outer seal, TPE grey	
902811, outer seal, TPE black	

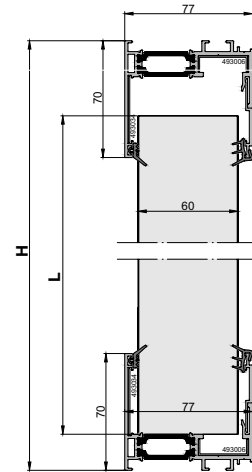

Façade 90° up to 12 m panel length*

* at Central European temperature conditions

top profile 456002
base profile 456001

Calculation of the panel length:

L in mm = height H in mm - 75 mm

Finishes	profile connector (PU 4 pcs.)
mill finish / anodized E6/C0 / powder coated according to RAL	
456002, top and lateral frame profile	493006, 493082
456001, base profile	493006, 493082
492093, front plate	493081
902902N, inner seal, TPE grey	
902912N, inner seal, TPE black	
902801, outer seal, TPE grey	
902811, outer seal, TPE black	

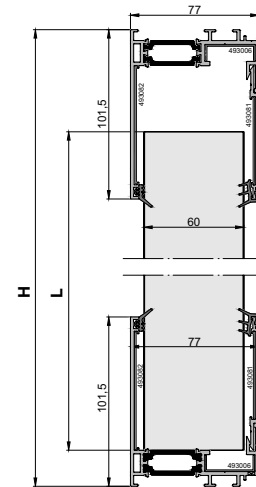

Façade 90° up to 4.5 m panel length*

* at Central European temperature conditions

top profile 456012
base profile 446062

Calculation of the panel length:

L in mm = height H in mm - 45 mm

Finishes	profile connector (PU 4 pcs.)
mill finish / anodized E6/C0 / powder coated according to RAL	
456012, top and lateral frame profile	493006, 493034
446062, traverse profile	493062, 493064, 493065, 493082
492042 / 43, front plate	
902902N, inner seal, TPE grey	
902912N, inner seal, TPE black	
902801, outer seal, TPE grey	
902811, outer seal, TPE black	

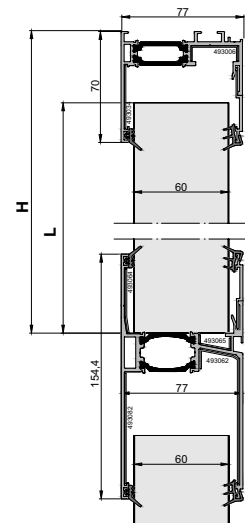

Calculation of the panel length Thermally broken frame system

Façade 90° up to 12 m panel length*

* at Central European temperature conditions

Calculation of the panel length:
L in mm = height H in mm - 55 mm

Finishes	profile connector (PU 4 pcs.)
mill finish / anodized E6/C0 / powder coated according to RAL	
456002, top and lateral frame profile	493006, 493082
492093, front plate	493081
446062, traverse profile	493062, 493064, 493065, 493082
492042 / 43, front plate	
902902N, inner seal, TPE grey	
902912N, inner seal, TPE black	
902801, outer seal, TPE grey	
902811, outer seal, TPE black	

top profile 456002
traverse profile 446062

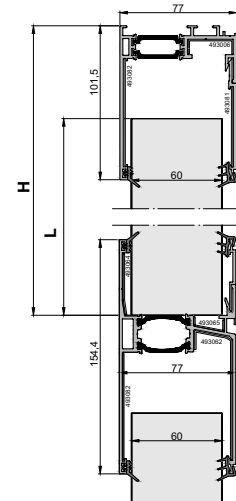

Façade 90° up to 12 m panel length*

* at Central European temperature conditions

Calculation of the panel length:
L in mm = height H in mm - 80 mm

Finishes	profile connector (PU 4 pcs.)
mill finish / anodized E6/C0 / powder coated according to RAL	
446062, traverse profile	493062, 493064, 493065, 493082
456011, base profile	493006, 493034
492042 / 43, front plate	
902902N, inner seal, TPE grey	
902912N, inner seal, TPE black	
902801, outer seal, TPE grey	
902811, outer seal, TPE black	

traverse profile 446062
base profile 456011

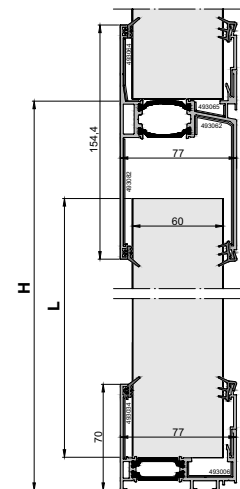

Façade 90° up to 12 m panel length*

* at Central European temperature conditions

Calculation of the panel length:
L in mm = height H in mm - 80 mm

Finishes	profile connector (PU 4 pcs.)
mill finish / anodized E6/C0 / powder coated according to RAL	
446062, traverse profile	493062, 493064, 493065, 493082
492042 / 43, front plate	
456001, base profile	493006, 493082
492093, front plate	493081
902902N, inner seal, TPE grey	
902912N, inner seal, TPE black	
902801, outer seal, TPE grey	
902811, outer seal, TPE black	

traverse profile 446062
base profile 456001

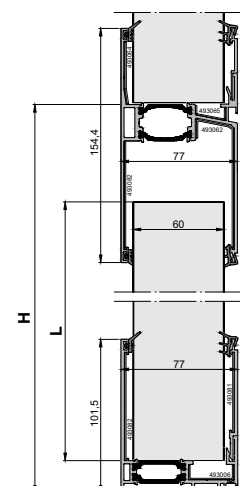

Calculation of the panel length Thermally broken frame system

Façade 90° up to 12 m panel length*

* at Central European temperature conditions

traverse profile 446062
traverse profile 446062

Calculation of the panel length:
L in mm = height H in mm - 60 mm

Finishes	profile connector (PU 4 pcs.)
mill finish / anodized E6/C0 / powder coated according to RAL	
446062, traverse profile	493062, 493064, 493065, 493082
492042 / 43, front plate	
902902N, inner seal, TPE grey	
902912N, inner seal, TPE black	
902801, outer seal, TPE grey	
902811, outer seal, TPE black	

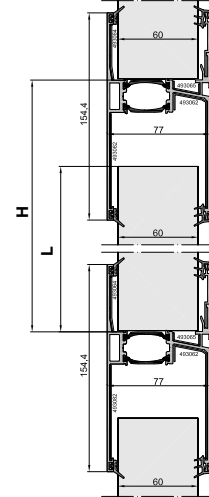

Pitched installation > 15° up to 4.5 m panel length*

* at Central European temperature conditions

top profile 456012
base profile 416051

Calculation of the panel length:
L in mm = height H in mm - 70 mm, at H ≤ 1,500 mm
L in mm = height H in mm - 65 mm, at H > 1,500 mm

Finishes	profile connector (PU 4 pcs.)
mill finish / anodized E6/C0 / powder coated according to RAL	
456012, top and lateral frame profile	493006, 493034
416051, base profile for pitched installation	493006, 493009, 493034
492042 / 43, front plate	
902902N, inner seal, TPE grey	
902912N, inner seal, TPE black	
902801, outer seal, TPE grey	
902811, outer seal, TPE black	

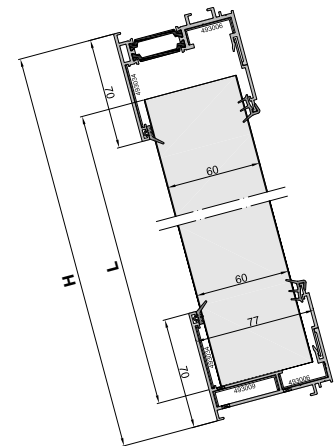

Pitched installation > 15° up to 12 m panel length*

* bei mitteleuropäischen Temperaturverhältnissen

top profile 456002
base profile 416051

Calculation of the panel length:
L in mm = height H in mm - 75 mm

Finishes	profile connector (PU 4 pcs.)
mill finish / anodized E6/C0 / powder coated according to RAL	
456002, top and lateral frame profile	493006, 493082
492093, front plate	493081
416051, base profile for pitched installation	493006, 493009, 493034
492042 / 43, front plate	
902902N, inner seal, TPE grey	
902912N, inner seal, TPE black	
902801, outer seal, TPE grey	
902811, outer seal, TPE black	

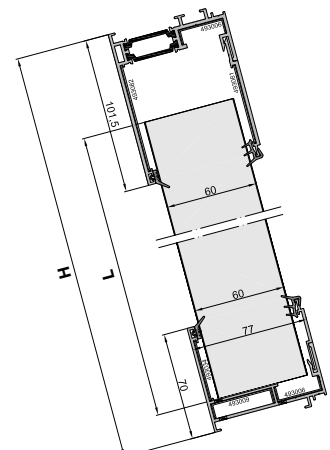

Calculation of the panel length Thermally broken frame system

Façade 90° up to 4.5 m panel length*

* at Central European temperature conditions

top profile 416012
base profile 416011

Calculation of the panel length:

L in mm = height H in mm - 70 mm, at H ≤ 1,500 mm

L in mm = height H in mm - 65 mm, at H > 1,500 mm

Finishes	profile connector (PU 4 pcs.)
mill finish / anodized E6/C0 / powder coated according to RAL	
416012, top and lateral frame profile	493006, 493009, 493034
416011, base profile	493006, 493009, 493034
492042 / 43, front plate	
902902N, inner seal, TPE grey	
902912N, inner seal, TPE black	
902801, outer seal, TPE grey	
902811, outer seal, TPE black	

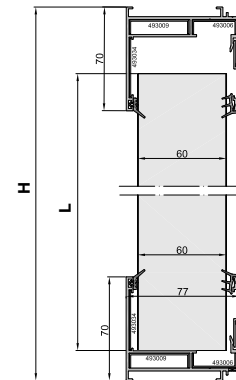

Pitched installation > 15° up to 4.5 m panel length*

* at Central European temperature conditions

top profile 416012
base profile 416051

Calculation of the panel length:

L in mm = height H in mm - 70 mm, at H ≤ 1,500 mm

L in mm = height H in mm - 65 mm, at H > 1,500 mm

Finishes	profile connector (PU 4 pcs.)
mill finish / anodized E6/C0 / powder coated according to RAL	
416012, top and lateral frame profile	493006, 493034
416051, base profile for pitched installation	493006, 493009, 493034
492042 / 43, front plate	
902902N, inner seal, TPE grey	
902912N, inner seal, TPE black	
902801, outer seal, TPE grey	
902811, outer seal, TPE black	

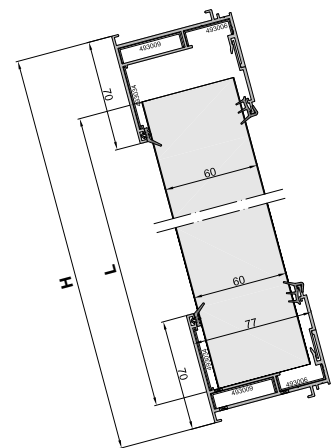

Window sills and accessories

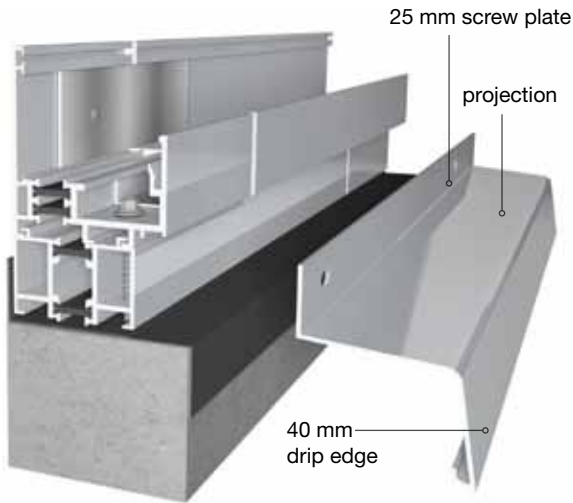

General

- Thermal expansion of the profiles: window sills over 3,000 mm in length must be cut in the middle and extended by using a profile connector. The window sills must be fastened to the frame and must be tight against rainwater. The expansion of the window sill must be ensured depending on the length.
- For sound insulation during heavy rain we recommend to provide window sills with a sound absorptive stripe. The sound absorptive area should be around 1/3 of the window sill area.
- Aluminium window sills should project about 40 mm over the finished façade. The profile width should be measured accordingly. This applies only for installations with side endpieces. Without side endpieces the projection of window sills should not be lower than 20 mm.
- From a projection/profile depth of 150 mm holders (Vario fastener or clinker fastener) are necessarily to be used on the structure (every 800 to 1,000 mm).

Window sills

Explanation of article numbers

XX	projection
05	50 mm
07	70 mm, in stock
09	90 mm
11	110 mm, in stock
13	130 mm
15	150 mm, in stock
18	180 mm
21	210 mm
24	240 mm
26	260 mm
30	300 mm
36	360 mm

Note for installation:

Before installation of the side endpieces, the sound absorptive stripes are to be fixed approx. 50 mm behind the beginning of the drip edge on the bottom side of the window sill. Approx. 40 mm on the front ends of the window sill have to left free in order to install the side endpieces.

Base profile and adapter profile are to be fixed to the supporting substructure before the window sill can be screwed to the adapter profile. The side endpieces are to be clipped on in advance. After clipping on the side endpieces and fastening the window sill, all connection joints have to be sealed. Please leave at least 5 mm on each side of the window sill for the thermal expansion. If implementing full thermal protection, it is important to make sure that the vario fastener is fixed before placing the insulation to the masonry. This also applies if using the holder for clinker installation.

The window sill with the protective foil side at the top is to be fixed at the adapter profile with window sill screws (standard slotted holes 4,2 x 7 mm). The protective foil has to be removed in the area of the side endpieces. Make sure to provide the final window sill slope of at least 5° after the assembly. When plastering the side elements please check the presence of expansion joints and keep in mind the thermal expansion of aluminium. Coarse mortar and plaster remnants must be removed immediately from the protective foil. After completion of the façade work in the window sill area, the protective foil has to be removed as quickly as possible.

Finishes

mill finish / anodized E6/C0 / powder coated according to RAL

other projections on request

Accessories

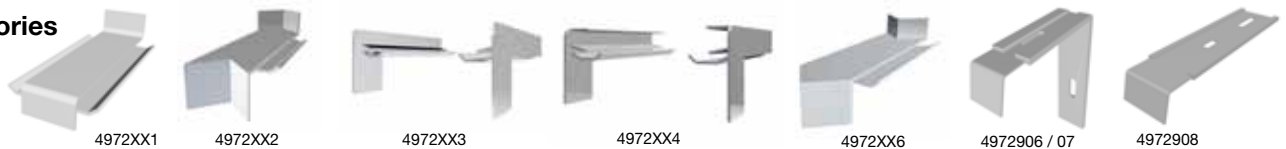

Article no.:		delivery unit
4971XX0	window sill with a projection of XX mm	6.0 m
4972XX1	profile connector for straight joints	pcs.
4972XX2	profile connector for inner corners 90° or 135°	pcs.
4972XX3	side endpiece on-wall (window sills should project approx. 40 mm over the finished façade)	pcs. (please specify left or / right)
4972XX4	side endpiece flush-mounted (window sills should project approx. 40 mm over the finished façade)	pcs. (please specify left or / right)
4972XX6	profile connector for outer corners 90° or 135°	pcs.
4972906 / 07	vario-fastener (fasteners are mandatory from a projection of 150 mm) variable sideslip bracket, to be fixed every 800-1,000 mm	pcs.
4972908	clinker-fastener (fasteners are mandatory from a projection of 150 mm) variable sideslip bracket, to be fixed every 800-1,000 mm	pcs.

Adapter profiles

General

Adapter profiles for connecting a window sill with variable projections are available for all profile series (series 41, 42 and series 45). When using an adapter profile, the height of the adapter profile has to be subtracted from the calculated panel length. When using a window sill with a projection of 150 mm or more than two adapter profiles above each other are to be used.

window sill projection 50 -130 mm

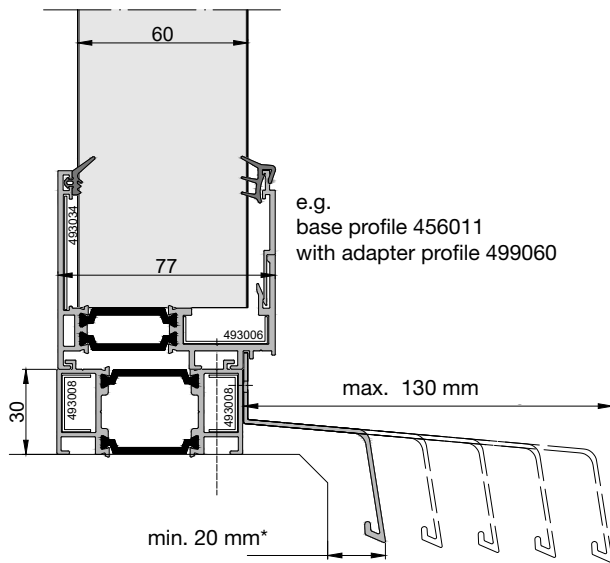

*approx. 40 mm when using side end pieces

window sill projection 150 - 360 mm

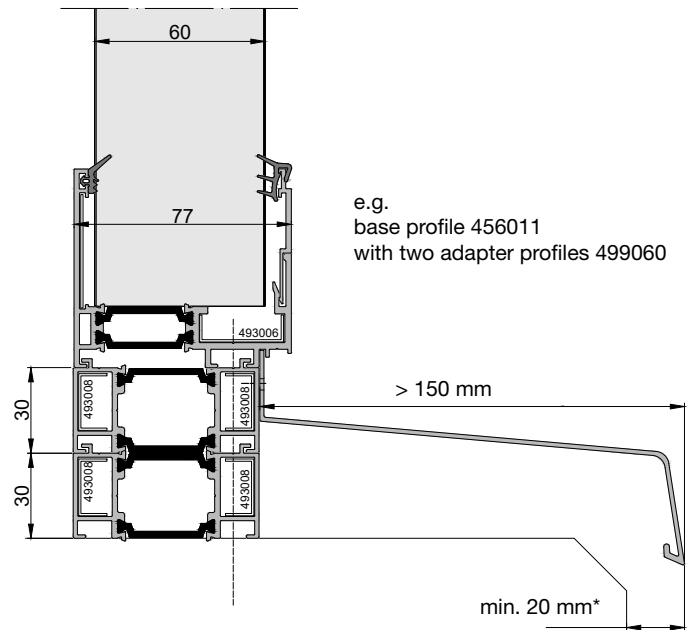

Profile series 45 499060



Adapter profiles

From a window sill projection of 150 mm, two adapter profiles must be used one above the other, the height of the adapter profile has to be subtracted from the calculated panel length.

Finishes	height	delivery length	profile connector (PU 4 pcs.)
mill finish / anodized E6/C0 / powder coated according to RAL 499060, thermally broken aluminium adapter profile for base profiles 456011 / 01 and 416011	30 mm	6.0 m	493008 (2 pcs. per joint)

